



CHAIN CONVEYOR CC500-600-750

CC500-600-750

ALTIMBİLEK Chain Conveyors, ensure powder and granule products to be transported as straight or inclined in the desired capacity in an economical way and without any damage. It has a completely closed and impermeable structure.

FEATURES

- Full Bolt Joint, Easy-to-assemble Body Structure
- Maximum Endurance
- Heat-treated Rotary Api Type Chain
- Bolt-fixed Plastic Pallets in the Chain
- Maximum Base Cleaning Performance with Angled Plastic Scraper Pallets
- Return Bucket on Each Scraper Pallet
- Impermeable Dust Seals
- Manual Screwed Tensioning System
- Multiple Loading and Unloading
- Bidirectional Product Transportation

DRIVE SYSTEM

- Drive System Mountable at Right or Left
- Power Transmission with Belt-Pulley Connection (Standard)
- Reducer Motor Hollow Shaft (Optional)
- Reducer Motor Full Shaft and Coupling (Optional)

SECURITY SYSTEM

- Speed Sensor (Standard)
- Excessive-product Detection Sensor (Standard)
- Chain Breaking Detection Sensor (Optional)
- Roller Heat Detection Sensor (Optional)
- Roller Pulse Detection Sensor (Optional)

ACCESSORIES

- Control Windows
- Inlet Module
- Outlet Module
- Housing for Rotating parts
- Raincoat and Sun Shield for Motor
- Support Legs with Height Adjustment
- Wear Plates (Optional)

TECHNICAL SPECIFICATIONS

Machine	CC500	CC600	CC750
Maximum Capacity	660m ³ /h	800m ³ /h	980m ³ /h
Maximum Chain Speed	0.82m/s		
Maximum Length and Slope	According to the product specifications		
Drive System	According to the application		
Sound Level	70-85 dB		
Operating Conditions	-15°C ÷ 40°C ambient temperature		

MATERIALS

Body	Standard	Galvanized Steel and Hot Dipped Galvanized Coating
	Optional	Stainless Painted
Wear Plates (Bottom and Sides)	Standard	None
	Optional	UHMW1000, Hardox
Chain	Standard	Steel, with Return Bucket
	Optional	Stainless
Scraper Pallet	Standard	Plastik (PP-COP)
	Optional	UHMW1000 Antistatic
Chain Return	Standard	Plastic Pullet (PA6)
	Optional	Slide

COMPATIBILITY

ATEX	Standard	Out of Zone
	Optional	Zone 22 - 21

NOTE: ATEX compatibility requires special requirements



CHAIN CONVEYOR CC500-600-750

CC500-600-750

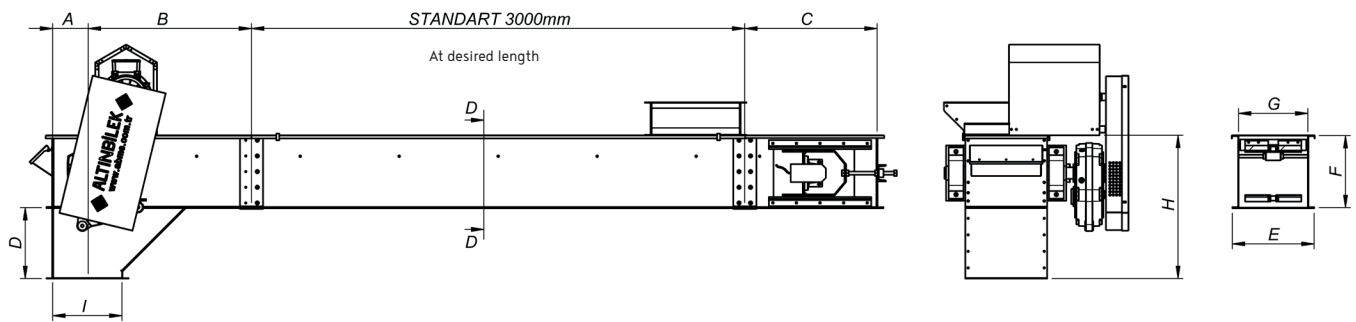

MODEL	A(mm)	B(mm)	C(mm)	D(mm)	E(mm)	F(mm)	G(mm)	H(mm)	I(mm)
CC500	410	1220	1150	360	900	750	820	1110	820x820
CC600	410	1220	1150	360	900	750	820	1110	820x820
CC750	410	1220	1150	360	900	750	820	1110	820x820

Designs and dimensions are subject to change without notice.